

14472

ESSENCE PRESSURE BALANCE VALVE TRIM WITH CARTRIDGE

Pure Freude
an Wasser





STANDARD SPECIFICATION:

- GROHE StarLight®
- GROHE SilkMove®
- Metal handle
- Metal trim plate with GROHE QuickFix®
- Includes pressure balance cartridge with double ceramic technology
- Flow Rate: 5.2gpm (bottom) and 3.0 gpm (top port) at 45 psi (19 l/min)
- For use with GrohSafe 3.0 Rough-in Valve (35 110, 35 111, 35 112, 35 113, 35 114, 35 115, 35 116)



PRODUCT FEATURES:





-  GROHE StarLight®
-  GROHE SilkMove®
-  GROHE QuickFix®

CERTIFICATIONS:



- ADA
- CSA B125.1
- ASME A112.18.1

AVAILABLE FINISHES:

- | | |
|----------|---|
| 14472000 |  StarLight® Chrome |
| 14472A00 |  Hard Graphite |
| 14472BE0 |  Polished Nickel InfinityFinish™ |
| 14472EN0 |  Brushed Nickel InfinityFinish™ |
| 14472GN0 |  Brushed Cool Sunrise |

NOTE: Install this product according to the installation guide. ADA, CSA compliant when installed to the specific requirements of these regulations.

Tel: 1.630.582.7711 Fax: 1.630.582.7722

We reserve the right to make revisions without notice to product specifications.

For the most current Specification Sheet, go to www.grohe.us.

03-19-2020

PART OF **LIXIL**

14472

ESSENCE PRESSURE BALANCE VALVE TRIM WITH CARTRIDGE

Pure Freude
an Wasser



TECHNICAL DATA:

Product Height	6-5/16 in
Product Length	6-5/16 in
Product Width	3-1/16 in

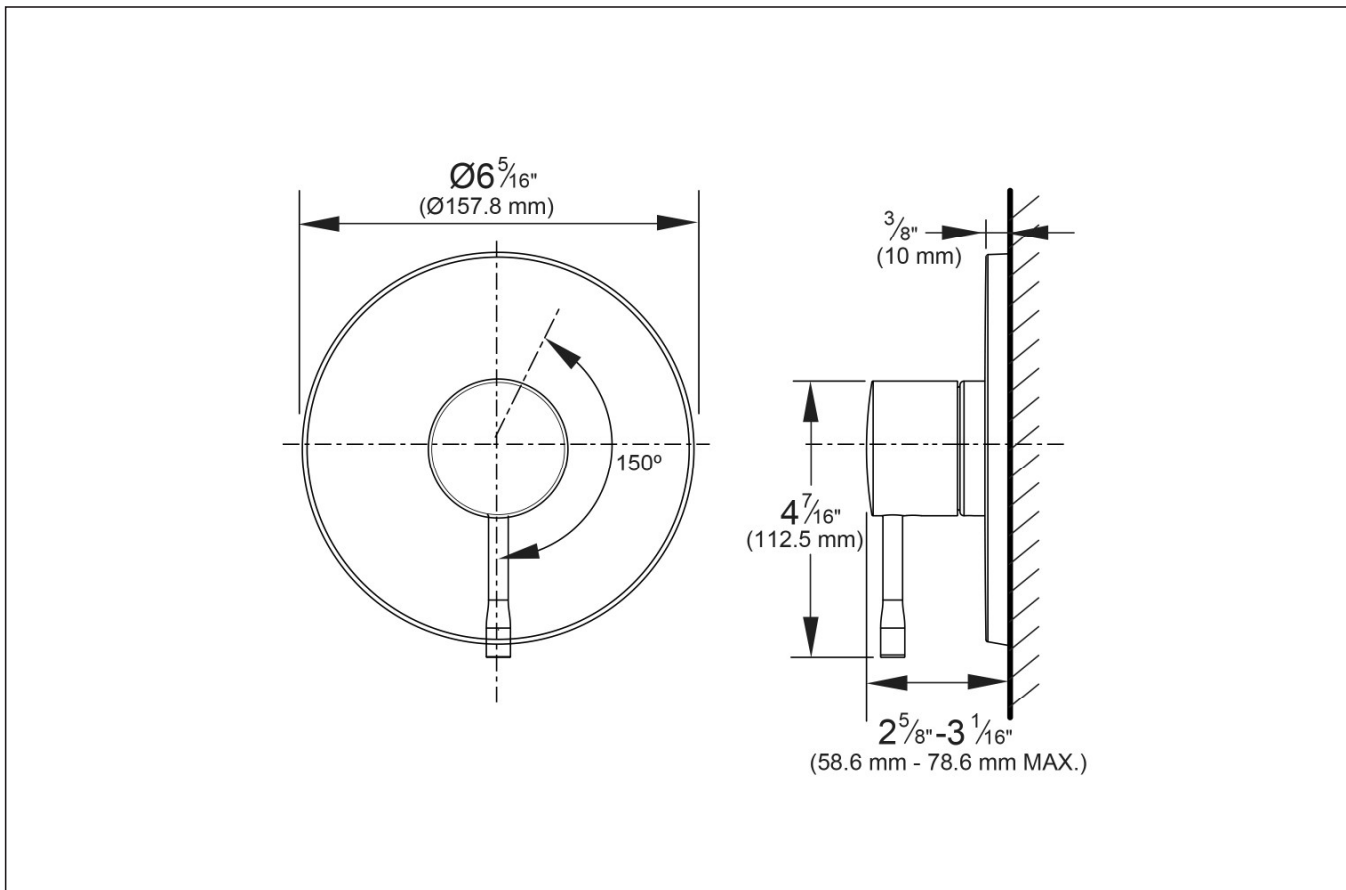

Tel: 1.630.582.7711 Fax: 1.630.582.7722
We reserve the right to make revisions without notice to product specifications.
For the most current Specification Sheet, go to www.grohe.us.
03-19-2020

PART OF LIXIL