

INSTALLATION INSTRUCTIONS

American Standard

Style That Works Better

Undercounter Sink

Oval Shaped Models: 0495, 0496, 0497, 0630, 0632

Introduction: Thank you for selecting our products...products which have been the benchmarks of fine quality for years. To help ensure that the installation process will proceed smoothly, please read these instructions carefully before you begin. Also, review the recommended tools and materials list; carefully unpack and examine your new plumbing fixture.

⚠ CAUTION: PRODUCT IS FRAGILE. TO AVOID BREAKAGE AND POSSIBLE INJURY HANDLE WITH CARE!
NOTE: Pictures may not exactly define contour of china and components.

Observe Local Plumbing and Building Codes.

Product names listed herein are trademarks of American Standard Inc. unless otherwise noted.

Recommended Tools & Materials



Putty Knife



Adjustable Wrench



Plumbers' Putty



Channel Lock Pliers

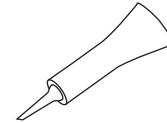

Silicone Adhesive

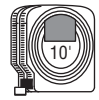

Tape Measure

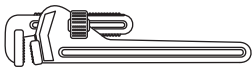

Pipe Wrench

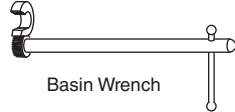

Basin Wrench

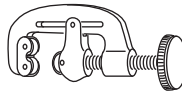

Tubing Cutter



Phillips Screwdriver



Regular Screwdriver

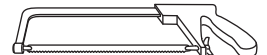

Hacksaw

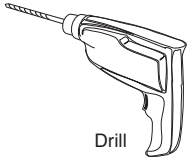

Drill



Saber Saw

NOTE: More specialized tools may be necessary to install this sink to countertop materials other than wood or wood composites.

1

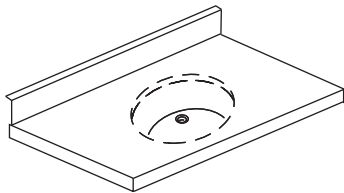

NOTE: To avoid damage to countertop, install sink such that future removal from underneath the countertop is possible.

First, make sure the clearance between the backsplash, faucet, fixtures and cabinets are acceptable for the new sink.

2

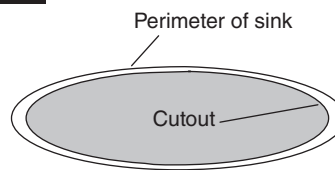

Carefully cut out the enclosed template, then position and trace the template on the countertop as shown on the template. Make a mark of the faucet hole centerline on the countertop. Drill a 1/2" pilot hole on the inside of the cut line. Use a saber saw or a keyhole saw to cut out the countertop opening.

3

FOR WOOD COUNTERTOP

Mark and pre-drill the wood screw holes as located on the enclosed template. Waterproof any exposed areas of wood.

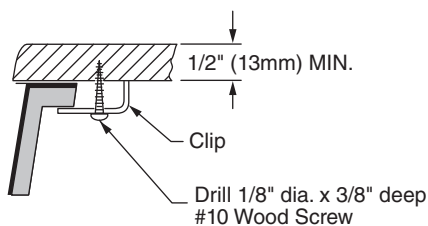

1/2" (13mm) MIN.

Clip

Drill 1/8" dia. x 3/8" deep #10 Wood Screw

4

FOR MARBLE OR SOLID SURFACE COUNTERTOP

To protect countertop, place it on a foam padding and drill 3/8" Dia. x 1/4" deep hole as per location shown on template. Clean countertop surface and sink surface where silicone caulking/adhesive is applied.

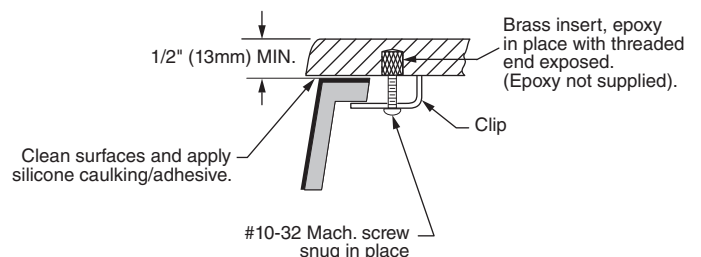

1/2" (13mm) MIN.

Brass insert, epoxy in place with threaded end exposed. (Epoxy not supplied).

Clip

Clean surfaces and apply silicone caulking/adhesive.

#10-32 Mach. screw snug in place

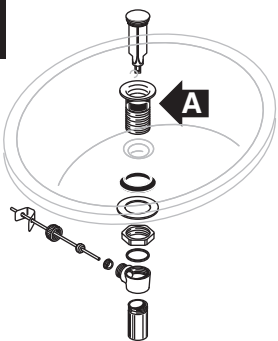
5

Mount the drain assembly (not included) on the sink, following faucet manufacturer's instructions. Be certain to apply a bead of sealing putty on the underside of the drain (Part "A") in order to ensure a watertight seal between the sink and drain. Remove excess putty after installing drain on sink.

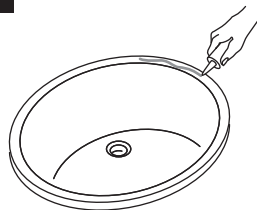
6

After checking fit and alignment of sink to cut out, apply a bead of silicone caulking/adhesive to rim of sink.

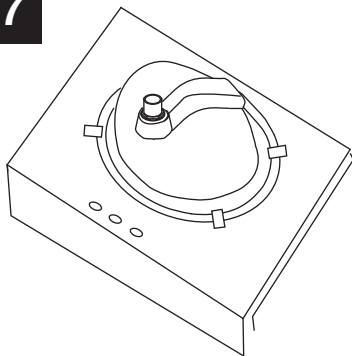
7

Center bowl over cutout and tighten screws (see step 4) to secure bowl to countertop. Remove excess sealant from inside lip.

NOTE: The screws provided should be used on countertops with a minimum 1" thickness. For thinner countertops, use appropriate anchors and fasteners.

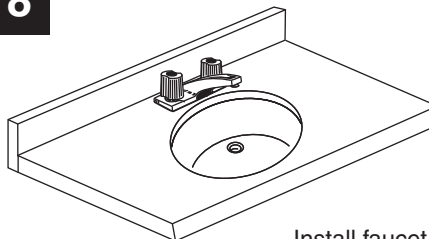
8

Install faucet (not included) and countertop (not included) following manufacturers instructions.

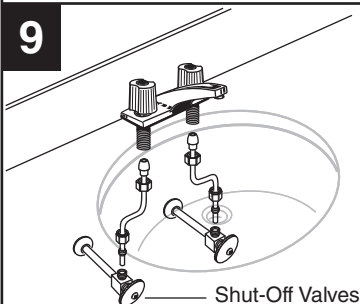
9

Connect supply line to faucet (finger tight) and carefully bend tubes to engage with the supply shut-off valves. Tighten connections at faucet and shut-off valves for water tight seal.

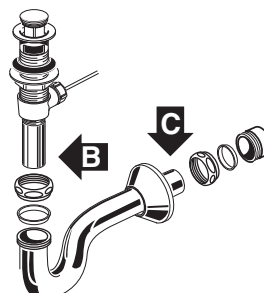
10

Connect trap to drain assembly hand tight to check alignment. It may be necessary to cut off part of the tailpiece (area "B") or part of the horizontal leg of the trap (area "C"). Secure joints for watertight assembly.

AS AMERICA, INC. ONE YEAR LIMITED WARRANTY

If inspection of this AS America, Inc. ("American Standard") plumbing product, within one year after its initial purchase, confirms that it is defective in materials or workmanship, American Standard will repair or, at its option, exchange the product for a similar model.

This limited warranty applies only to the original purchaser and installation of these products. In the event of a limited warranty claim, proof of purchase will be required—save sales receipt.

This limited warranty does not apply to local building code compliance. Since local building codes vary considerably, the purchaser of this product should check with a local building or plumbing contractor to insure local code compliance before installation.

This limited warranty is void if the product has been moved from its initial place of installation; if it has been subjected to faulty maintenance, abuse, misuse, accident or other damages; if it was not installed in accordance with American Standard's instructions; or if it has been modified in a manner inconsistent with the product as shipped by American Standard.

American Standard's option to repair or exchange the product under this limited warranty does not cover any labor or other costs of removal or installation. IN NO EVENT WILL AMERICAN STANDARD BE LIABLE FOR THE COST OF REPAIR OR REPLACEMENT OF ANY INSTALLATION MATERIALS, INCLUDING BUT NOT LIMITED TO, TILES, MARBLE, ETC. American Standard will not be responsible for any other incidental or consequential damages attributable to a product defect or to the repair or exchange of a defective product, all of which are expressly excluded from this limited warranty. This limited warranty does not cover any liability for consequential or incidental damages, all of which are hereby expressly disclaimed, or the extension beyond the duration of this limited warranty of any implied limited warranties, including those of merchantability or fitness for an intended purpose. (Some states or provinces do not allow the exclusion or limitation of implied limited warranties, so this exclusion may not apply to you.)

This limited warranty gives you specific legal rights. You may have other statutory rights that vary from state to state or from province to province, in which case this limited warranty does not affect such statutory rights.

In the United States:

American Standard Brands
P.O. Box 6820
Piscataway, New Jersey 08855
Attention: Director of Customer Care
For residents of the United States, warranty information may also be obtained by calling the following toll free number: (800) 442-1902
www.americanstandard.com

In Canada:

AS Canada, ULC
5900 Avebury Rd.
Mississauga, Ontario
Canada L5R 3M3
Toll Free: (800) 387-0369
www.americanstandard.ca

In Mexico:

American Standard B&K Mexico
S. de R.L. de C.V.
Via Morelos #330
Col. Santa Clara
Ecatepec 55540 Edo. Mexico
Toll Free: 01-800-839-1200
www.americanstandard.com.mx